

CATALOGUS



LAMPEN



Ninoofsesteenweg 38 , 1500 Halle
Tel.: 02/360.22.10 - Fax.: 02/360.25.90

Beste klant,

Uiteindelijk is hij er, het eerste deel van de door u zoveel gevraagde catalogus. In dit eerste deel vindt u alle lampen en lamphouders die wij op voorraad hebben. Het is onze bedoeling om deze catalogus geleidelijk artikelgroep per artikelgroep uit te breiden tot een volledige catalogus met alle voorraadartikels.

Ondanks alle zorg die aan deze uitgave is besteed blijven vergissingen mogelijk. De uitgever kan daarvoor echter geen aansprakelijkheid aanvaarden. Alle suggesties en opmerkingen worden echter in dank aanvaard.

Multitronics

© 2001 Multitronics Niets uit deze uitgave mag verveelvoudigd en/of openbaar gemaakt worden door middel van druk, fotokopie, microfilm of welke andere wijze ook, zonder voorafgaande schriftelijke toestemming van de uitgever.

© 2001 Multitronics Aucune partie de l'ouvrage ne peut être reproduite sous quelque forme que ce soit par impression, photocopie, microfilm ou autre procédé, sans autorisation écrite de l'editeur.

INHOUDSTABEL

LAMPEN	3
LAMPEN	3
DRAADLAMPJE Ø 3 x 12mm	3
DRAADLAMPJE Ø 4 x 12mm	3
DRAADLAMPJE (T¼) Ø4,2 x 11,7mm	3
DRAADLAMPJE AXIAAL Ø4,3 x 20mm	3
BI-PIN STEEKLAMPJE Ø3 x 7mm	4
BI-PIN STEEKLAMPJE Ø4,7 x 9mm	4
STEEKLAMPJE (wedge-base T5) Ø5 x 20mm	4
STEEKLAMP (wedge-base T10) Ø10 x 26,8mm	4
BUISLAMPJE (E5,5) Ø5,8 x 17,5mm	5
BALLON-LAMP (E10) Ø11 x 23mm	5
BALLON-LAMP (E10) Ø15 x 29mm	5
KEGEL-LENSLAMP (E10) Ø9,5 x 24mm	5
BOL-LENSLAMP (E10) Ø11,5 x 24mm	6
BUISLAMP (E10) Ø10 x 28mm	6
BUISLAMP (E14) Ø15 x 48mm	6
BUISLAMP (E14) Ø22 x 49mm	6
BUISLAMP (E14) Ø26 x 57mm	7
BUIS-LENSLAMP FLENS-VOET Ø4,2 x 15mm	7
BUISLAMP (Ba7s) Ø6,8 x 20mm	7
BUISLAMP (Ba9s) Ø10 x 28mm	7
TOORTS-LAMP (P13,5s) Ø11 x 30mm	8
TOORTS-LENSLAMP (P13,5s) Ø9 x 28mm	8
KNIPPER-BUISLAMP (E10) Ø10 x 28mm	8
KNIPPER-BALLONLAMP (Ba9s) Ø15 x 27mm	8
BUISZEKERING-LAMP Ø6 x 30mm	9
AUTO-LAMP (Ba15s) Ø18 x 37mm	9
AUTO-LAMP (Ba15s) Ø26,5 x 46,5mm	9
AUTO-LAMP (B15d) Ø26,5 x 46,5mm	9
AUTO-LAMP HALOGEEN (H1-P14,5S) Ø8,5 x 59mm	10
AUTO-LAMP HALOGEEN (H3-PK22S) Ø11,5 x 42mm	10
AUTO-LAMP HALOGEEN (H4-P43T) Ø17 x 75mm	10
AUTO-LAMP HALOGEEN (H7-PX26D) Ø15 x 60mm	10
NEON DRAADLAMPJE Ø4 x 10mm	11
NEON DRAADLAMPJE Ø6 x 16mm	11
NEON BUISLAMP (Ba7s) Ø6,8 x 20mm	11
NEON BUISLAMP (E10) Ø10 x 28mm	11
NEON BUISLAMP (E14) Ø14 x 30mm	11
PAR36 LAMP Ø113 x 70mm	12
LAMPHOUDERS OPEN MODEL	12
LAMPHOUDERS GESLOTEN MODEL	13
NEON / FLUO SIGNAALLAMP	13

LAMPEN**LAMPEN****DRAADLAMPJE Ø 3 x 12mm**

Miniatur gloeilampje met twee lange (30 cm) geïsoleerde draden.

**Bestelcode spanning stroom vermogen**

LL110	4,5V	60mA	..	0,27W
LL111	6V	60mA	..	0,36W
LL112	6,3V	25mA	..	0,16W
LL113	6,3V	40mA	..	0,25W
LL114	6,3V	80mA	..	0,5W
LL115	8V	40mA	..	0,32W

Bestelcode spanning stroom vermogen

LL116	8V	60mA	..	0,48W
LL117	8V	80mA	..	0,64W
LL118	12V	40mA	..	0,48W
LL119	12V	60mA	..	0,72W
LL120	14V	40mA	..	0,56W
LL121	14V	65mA	..	0,90W

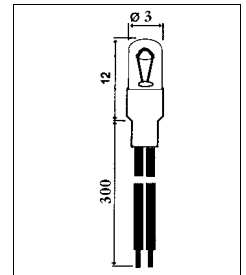
**DRAADLAMPJE Ø 4 x 12mm**

Miniatur gloeilampje met twee lange (30 cm) geïsoleerde draden.

**Bestelcode spanning stroom vermogen**

LL210	4,5V	60mA	..	0,27W
LL211	6V	60mA	..	0,36W
LL212	6,3V	25mA	..	0,16W
LL213	6,3V	40mA	..	0,25W
LL214	6,3V	80mA	..	0,5W
LL215	8V	40mA	..	0,32W
LL216	8V	60mA	..	0,48W

Bestelcode spanning stroom vermogen

LL217	8V	80mA	..	0,64W
LL218	12V	40mA	..	0,48W
LL219	12V	60mA	..	0,72W
LL220	14V	40mA	..	0,56W
LL221	14V	65mA	..	0,90W
LL224	24V	50mA	..	1,2W

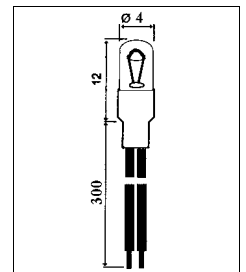
**DRAADLAMPJE (T¼) Ø4,2 x 11,7mm**

Miniatur gloeilampje met twee niet geïsoleerde draden.

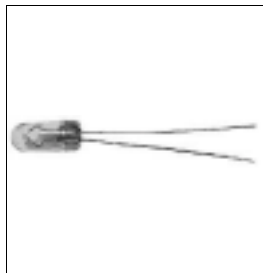
**Bestelcode spanning stroom vermogen**

72-30	5V	60mA	..	0,3W
72-31	5V	115mA	..	0,6W
72-32	6V	40mA	..	0,2W
72-33	6V	60mA	..	0,4W
72-34	12V	35mA	..	0,4W
72-34a	12V	80mA	..	1W

Bestelcode spanning stroom vermogen

72-35	14V	80mA	..	1,1W
72-35a	24V	35mA	..	0,8W
72-36	28V	25mA	..	0,7W
72-37	28V	40mA	..	1,1W
72-38	48V	25mA	..	1,2W

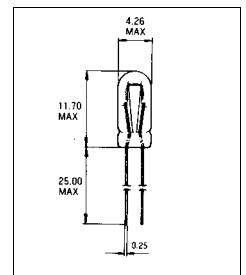
**DRAADLAMPJE AXIAAL Ø4,3 x 20mm**

Axiaal miniatur gloeilampje met twee niet geïsoleerde draden.

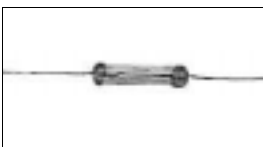
**Bestelcode spanning stroom vermogen**

72-303	3V	50mA	..	0,15W
72-306	5V	50mA	..	0,3W

Bestelcode spanning stroom vermogen

72-309	9V	50mA	..	0,45W
72-312	12V	50mA	..	0,6W

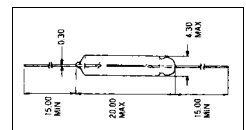

LAMPEN

BI-PIN STEEKLAMPJE Ø3 x 7mm

Bi-pin steeklampje vooral gebruikt in compacte zaklampen.



Bestelcode spanning stroom vermogen

72-102 1,2V . . . 200mA . . . 0,24W
72-105 2,3V . . . 270mA . . . 0,62W

Bestelcode spanning stroom vermogen

72-106 2,4V . . . 350mA . . . 0,84W

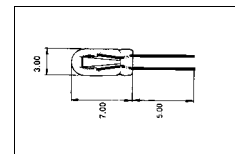

BI-PIN STEEKLAMPJE Ø4,7 x 9mm

Bi-pin steeklampje vooral gebruikt in compacte zaklampen.

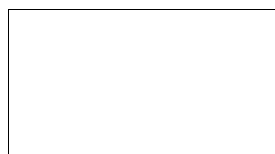

Bestelcode spanning stroom vermogen

72-116 2,4V . . . 350mA . . . 0,84W

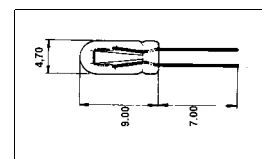

STEEKLAMPJE (wedge-base T5) Ø5 x 20mm

Steeklampje, volledig in glas, met twee zijdelingse contacten.



Bestelcode spanning stroom vermogen

72-2306 6V . . . 30mA . . . 0,18W
72-2322 12V . . . 30mA . . . 0,36W
72-2321 12V . . . 80mA 1W
72-2342 24V . . . 30mA . . . 0,7W
72-2341 24V . . . 40mA 1W

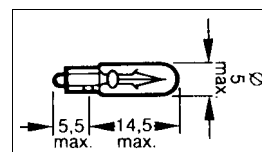

STEEKLAMP (wedge-base T10) Ø10 x 26,8mm

Steeklamp, volledig in glas, met twee zijdelingse contacten.



Bestelcode spanning stroom vermogen

72-2521 12V . . . 165mA 2W
72-2821 12V . . . 250mA 3W
72-2826 12V . . . 416mA 5W
72-2541 24V . . . 83mA 2W
72-2545 24V . . . 125mA 3W



BUISLAMPJE (E5,5) Ø5,8 x 17,5mm

Buis-gloeilampje met E5,5 voet geschikt voor onder andere lamphouder M575-serie

**Bestelcode spanning stroom vermogen**

72-10156 6V	... 40mA	... 0,2W
72-10157 12V	... 40mA	... 0,5W
72-10159 28V	... 40mA	... 1W

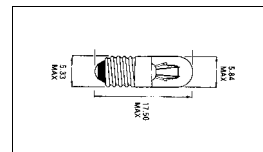
**BALLON-LAMP (E10) Ø11 x 23mm**

Ballonvormig gloeilampje met E10 voet.

**Bestelcode spanning stroom vermogen**

75-2001 1,5V	... 90mA	... 0,13W
75-2006 2,5V	... 200mA	... 0,5W
75-2010 3,5V	... 200mA	... 0,7W
75-2012 3,8V	... 70mA	... 0,3W
75-2014 4V	... 300mA	... 1,2W
75-2017 6V	... 60mA	... 0,4W

Bestelcode spanning stroom vermogen

75-2018 6V	... 100mA	... 0,6W
75-2019 6V	... 350mA	... 2,1W
75-2024 6V	... 830mA	... 5W
75-2025 12V	... 50mA	... 0,6W
75-2068 12V	... 100mA	... 1,2W
75-2026 12V	... 250mA	... 3W
75-2078 24V	... 100mA	... 2,4W

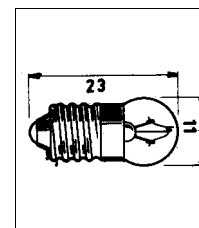
**BALLON-LAMP (E10) Ø15 x 29mm**

Ballonvormig gloeilampje met E10 voet.

**Bestelcode spanning stroom vermogen**

75-2128 6V 1A 6W
75-2149 12V	... 500mA	... 6W

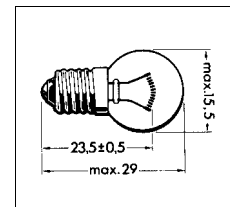
**KEGEL-LENSLAMP (E10) Ø9,5 x 24mm**

Kegelvormig gloeilampje met bovenaan een ingebouwde lens voor hogere lichtopbrengst.

**Bestelcode spanning stroom vermogen**

75-3201 1,2V	... 220mA	... 0,26W
75-3202 2,2V	... 180mA	... 0,4W
75-3203 2,2V	... 250mA	... 0,55W
75-3204 2,5V	... 200mA	... 0,5W
75-3206 3,7V	... 300mA	... 1,1W

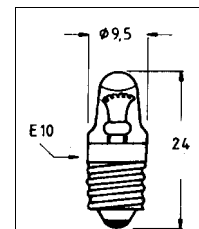

LAMPEN

BOL-LENSLAMP (E10) Ø11,5 x 24mm

Bolvormig gloeilampje met bovenaan een ingebouwde lens voor hogere lichtopbrengst.



Bestelcode spanning stroom vermogen

75-3211 2,2V	... 300mA	... 0,66W
75-3213 3,3V	... 300mA	... 1W
75-3214 3,7V	... 300mA	... 1,1W

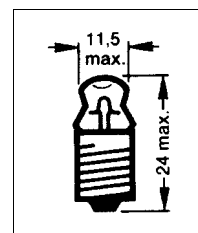

BUISLAMP (E10) Ø10 x 28mm

Buisvormig gloeilampje met E10 voet.



Bestelcode spanning stroom vermogen

75-99 4V	... 100mA	... 0,4W
75-215 6V	... 50mA	... 0,3W
75-110 6V	... 100mA	... 0,6W
75-117 6V	... 300mA	... 1,8W
75-120 7V	... 100mA	... 0,7W
75-122 7V	... 300mA	... 2,1W
75-123 8V	... 300mA	... 2,4W
75-129 12V	... 50mA	... 0,6W
75-130 12V	... 100mA	... 1,2W
75-131 12V	... 165mA	... 2W

Bestelcode spanning stroom vermogen

75-133 12V	... 250mA	... 3W
75-140 18V	... 100mA	... 1,8W
75-144 24V	... 50mA	... 1,2W
75-145 24V	... 80mA	... 2W
75-161 36V	... 50mA	... 1,8W
75-250 48V	... 50mA	... 2,4W
75-178 60V	... 40mA	... 2,4W
75-190 240V	... 12mA	... 3W

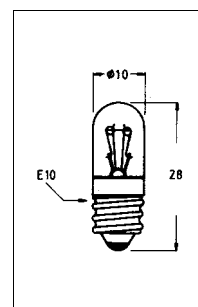

BUISLAMP (E14) Ø15 x 48mm

Buisvormige gloeilamp met E14 voet speciaal gebruikt in nachtverlichtings-apparaten.

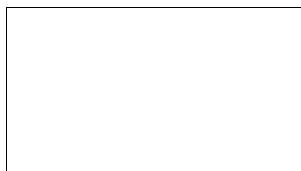

Bestelcode spanning vermogen

75-5141 230V 10W
----------------	------------	-----------

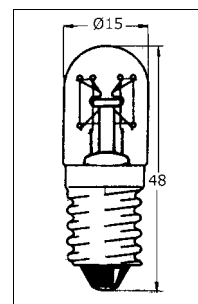

BUISLAMP (E14) Ø22 x 49mm

Buisvormige gloeilamp met E14 voet bestand tegen temperaturen tot 300 °C die gebruikt wordt onder andere in ovens.



Bestelcode spanning stroom vermogen

75-5055 230V	... 65mA	... 15W
----------------	------------	----------	---------

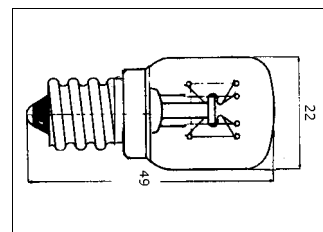

BUISLAMP (E14) Ø26 x 57mm

Buisvormige gloeilamp met E14 voet die onder andere gebruikt wordt als koelkast verlichting.



Bestelcode spanning stroom vermogen

75-5050 230V . . . 65mA . . 15W

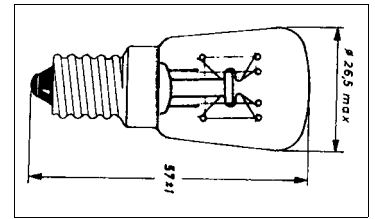

BUIS-LENSLAMP FLENS-VOET Ø4,2 x 15mm

Buisvormig gloeilampje met flens insteekvoet en met bovenaan een ingebouwde lens voor hogere lichtopbrengst. Dit lampje wordt gebruikt als verlichtingslampje in sleutelhangers.



Bestelcode spanning stroom vermogen

72-10093 1,5V . . . 60mA 0,09W

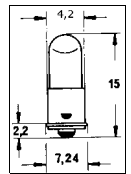

BUISLAMP (Ba7s) Ø6,8 x 20mm

Buisvormig gloeilampje met Ba7s voet.



Bestelcode spanning stroom vermogen

76-9 6V . . 100mA . . 0,6W
76-51 6V . . 200mA . . 1,2W
76-55 12V . . 100mA . . 1,2W
76-19 12V . . 165mA . . 2W
76-71 24V . . 50mA . . 1,2W
76-29 24V . . 80mA . . 2W
76-78 24V . . 100mA . . 2,4W
76-41 36V . . 50mA . . 1,8W

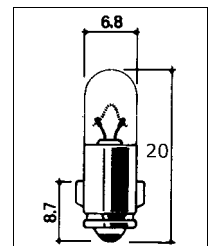

BUISLAMP (Ba9s) Ø10 x 28mm

Buisvormige gloeilamp met Ba9s voet.



Bestelcode spanning stroom vermogen

76-151 6V . . 180mA . . 1,1W
76-153 6V . . 350mA . . 2,1W
76-173 7V . . 100mA . . 0,7W
76-179 12V . . 100mA . . 1,2W
76-181 12V . . 165mA . . 2W
76-197 24V . . 80mA . . 2W
76-243 60V . . 20mA . . 1,2W

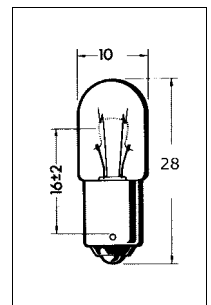

LAMPEN

TOORTS-LAMP (P13,5s) Ø11 x 30mm

Fakkelvormige gloeilamp met P13,5s voet die veel gebruikt wordt in zaklampen.



Bestelcode spanning stroom vermogen

76-407	2,4V ..	500mA ..	1,2W
76-405	2,4V ..	700mA ..	1,7W
76-409	2,5V ..	300mA ..	0,75W
76-415	3,6V ..	500mA ..	1,8W
76-406	3,6V ..	750mA ..	2,7W
76-417	3,7V ..	300mA ..	1,1W
76-419	4,8V ..	500mA ..	2,4W
76-421	6V ..	500mA ..	3W
76-422	6V ..	750mA ..	4,5W
76-423	7,2V ..	500mA ..	3,6W
76-427	12,5V ..	250mA ..	3W

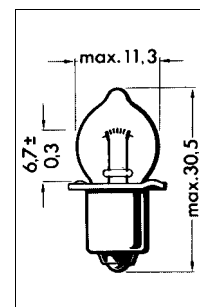

TOORTS-LENSLAMP (P13,5s) Ø9 x 28mm

Fakkelvormige gloeilamp met P13,5s voet en met bovenaan een ingebouwde lens voor hogere lichtopbrengst.



Bestelcode spanning stroom vermogen

76-433	2,2V ..	300mA ..	0,66W
76-437	3,7V ..	300mA ..	1,1W

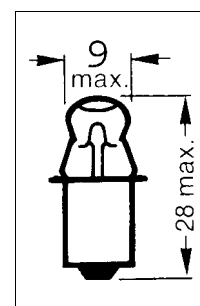

KNIPPER-BUISLAMP (E10) Ø10 x 28mm

Automatisch knipperende buislamp met E10 voet.



Bestelcode spanning

76-441	2,5V
76-445	4,8V

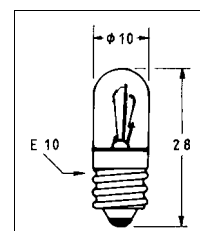

KNIPPER-BALLONLAMP (Ba9s) Ø15 x 27mm

Automatisch knipperende ballonlamp met Ba9s voet.



Bestelcode spanning stroom vermogen

76-451	6,5V ..	500mA ..	3,2W
---------------------	---------	----------	------

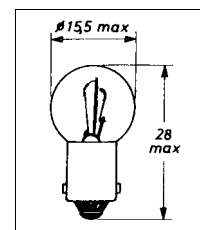

BUISZEKERING-LAMP Ø6 x 30mm

Buisvormige axiale lampjes gebruikt als interne verlichting in hi-fi apparatuur.



Bestelcode spanning stroom vermogen

PL201	6,3V	..	150mA	...	1W
PL202	6,3V	..	250mA	...	1,6W
PL203	6,3V	..	300mA	...	1,9W
PL204	8V	..	150mA	...	1,2W
PL205	8V	..	250mA	...	2W
PL206	8V	..	300mA	...	2,4W
PL207	12,6V	..	150mA	...	1,9W
PL208	12,6V	..	250mA	...	3,2W

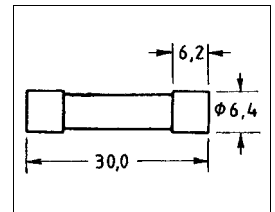

AUTO-LAMP (Ba15s) Ø18 x 37mm



Bestelcode spanning stroom vermogen

76-1010	12V	...	400mA	5W
76-1012	12V	...	830mA	10W

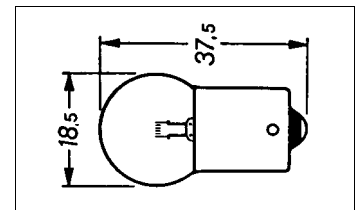

AUTO-LAMP (Ba15s) Ø26,5 x 46,5mm



Bestelcode spanning stroom vermogen

76-1044	12V	1,7A	21W
----------------	-------	-----	-------	------	-------	-----

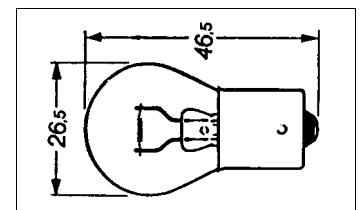

AUTO-LAMP (B15d) Ø26,5 x 46,5mm

Deze autolamp heeft twee filamenten, één van 21W en één van 5W.



Bestelcode spanning vermogen

76-3026	12V	5W+21W
----------------	-------	-----	-------	--------

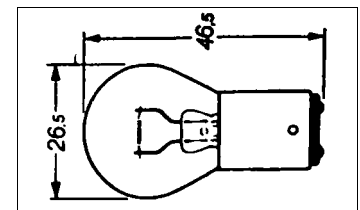

LAMPEN

AUTO-LAMP HALOGEEN (H1-P14,5S) Ø8,5 x 59mm



Bestelcode spanning stroom vermogen

71-560 12V 4,6A 55W

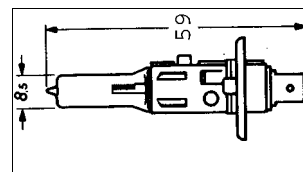

AUTO-LAMP HALOGEEN (H3-PK22S) Ø11,5 x 42mm



Bestelcode spanning stroom vermogen

71-620 12V 4,6A 55W

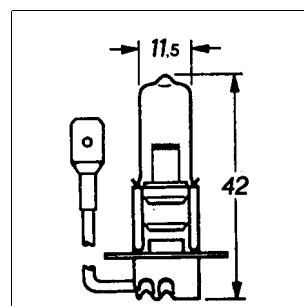

AUTO-LAMP HALOGEEN (H4-P43T) Ø17 x 75mm



Bestelcode spanning vermogen

71-640 12V 60/55W

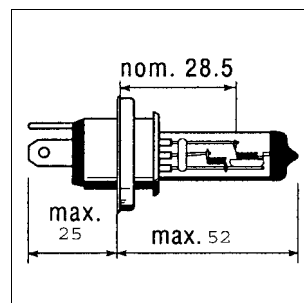

AUTO-LAMP HALOGEEN (H7-PX26D) Ø15 x 60mm



Bestelcode spanning vermogen

71-670 12V 55W

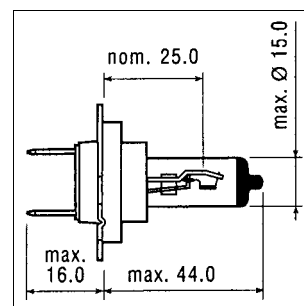

NEON DRAADLAMPJE Ø4 x 10mm

Miniatuur neon lampje met twee niet geïsoleerde draden dat meestal gebruikt wordt met een voorschakel weerstand in 230 V_{ac}

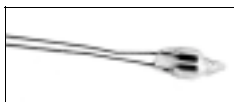

Bestelcode spanning stroom

69-10 65-85V . . . 0,6mA

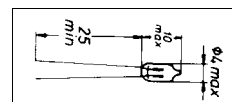

NEON DRAADLAMPJE Ø6 x 16mm

Miniatuur neon lampje met twee niet geïsoleerde draden dat meestal gebruikt wordt met een voorschakel weerstand in 230 V_{ac}



Bestelcode spanning stroom

69-11 65-85V . . 0,6mA

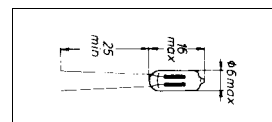

NEON BUISLAMP (Ba7s) Ø6,8 x 20mm

Neon buislamp met Ba7s voet en met bovenaan een ingebouwde lens voor hogere lichtopbrengst. Dit lampje wordt meestal gebruikt in lamphouders voor 230 V_{ac}



Bestelcode spanning stroom

69-26 220V . . 1,5mA

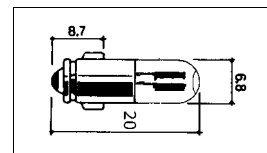

NEON BUISLAMP (E10) Ø10 x 28mm

Neon buislamp met E10 voet en met bovenaan een ingebouwde lens voor hogere lichtopbrengst. Dit lampje wordt meestal gebruikt in lamphouders voor 230 V_{ac}



Bestelcode spanning stroom

69-30 220V . . . 1,3mA

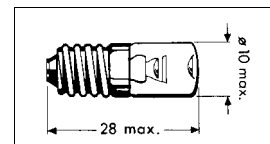

NEON BUISLAMP (E14) Ø14 x 30mm

Neon buislamp met E14 voet en met bovenaan een ingebouwde lens voor hogere lichtopbrengst. Deze lamp wordt meestal gebruikt in lamphouders voor 230 V_{ac}



Bestelcode spanning stroom

69-51 220V . . . 1,3mA

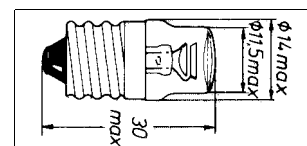

LAMPEN

PAR36 LAMP Ø113 x 70mm

Deze PAR 36 spotlamp met schroefaansluiting wordt gebruikt in diverse licht-effect toestellen.

Bestelcode spanning stroom vermogen

PAR36-LAMP .. 6V 5A 30W

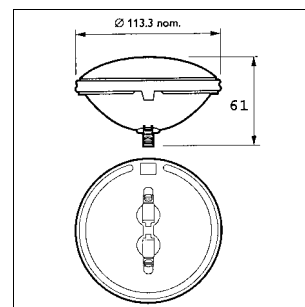

LAMPHOUDERS OPEN MODEL

Bestelcode : 30-1

Brugvormige metalen lamphouder geschikt voor lampjes met E10 voet.

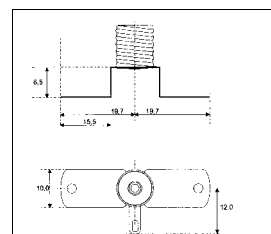

Bestelcode : 30-2

Metalen lamphouder met twee soldeerlipjes geschikt voor lampjes met E10 voet.

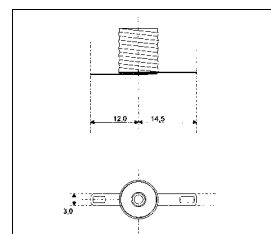

Bestelcode : 30-4

Lamphouder uit kunststof met schroefaansluiting geschikt voor lampjes met E10 voet.



Bestelcode : 30-6

Metalen lamphouder met twee print contacten geschikt voor lampjes met E10 voet.

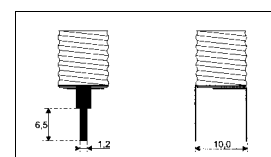
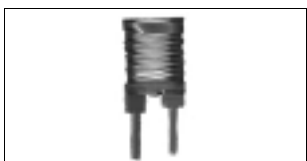

LAMPHOUDERS GESLOTEN MODEL



Ronde signaallamp met soldeeraansluiting, klein model, met interne houder voor een E5,5 lampje, beschikbaar in 5 kleuren.

- Bestelcode** kleur
M575B blauw
M575R rood
M575G groen
M575O oranje
M575T transparant

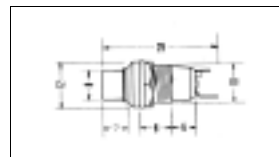

Ronde signaallamp met soldeeraansluiting en met interne houder voor een E10 lampje, beschikbaar in 4 kleuren.

- Bestelcode** kleur
SB514B blauw
SB514R rood
SB514G groen
SB514O oranje

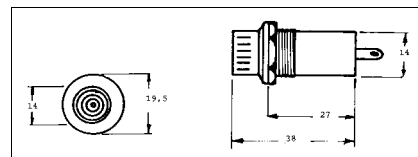

Professionele ronde signaallamp met schroefaansluiting en met interne houder voor een E10 lampje, beschikbaar in 5 kleuren.

- Bestelcode** kleur
RAF-B blauw
RAF-R rood
RAF-G groen
RAF-O oranje
RAF-W wit

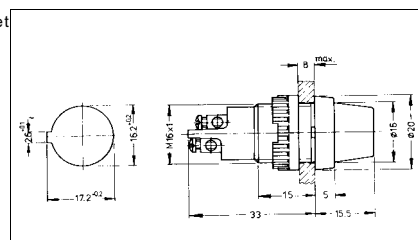

NEON / FLUO SIGNAALLAMP



Miniatuur signaallamp met 2 geïsoleerde draden, rond model, met interne neon-lamp van 230 V_{ac}

- Bestelcode** kleur
SL036R rood

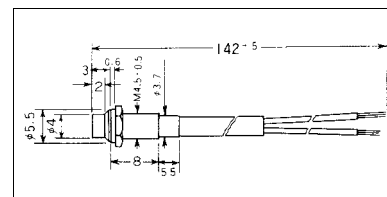

Kleine ronde signaallamp met interne neon-lamp(rood + oranje) of fluorescentielamp (groen) van 230 V_{ac} . Aansluiting gebeurt door middel van soldeerlipjes.

- Bestelcode** kleur
BN230R rood
BN230G groen
BN230O oranje

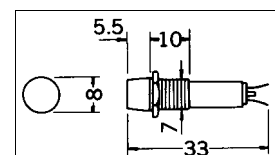

LAMPEN



Ronde signaallamp met interne neon-lamp(rood + oranje) of fluorescentielamp (groen) van 230 V_{ac} . Aansluiting gebeurt door middel van soldeerlijpjes.

Bestelcode kleur
N107R rood
N107G groen
N107O oranje

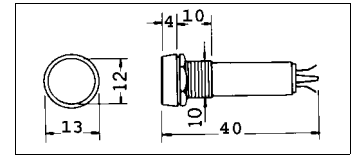

Rechthoekige signaallamp met interne neon-lamp(rood + oranje) of fluorescentielamp (groen) van 230 V_{ac} . Aansluiting gebeurt door middel van soldeerlijpjes.

Bestelcode kleur
IB108R rood
IB108G groen
IB108O oranje

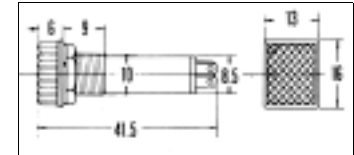



Ninoofsesteenweg 38 , 1500 Halle
Tel.: 02/360.22.10 - Fax.: 02/360.25.90